

Table of Contents

WELCOME TO POF-USA 3

RIFLE DESCRIPTION..... 3

EYE AND EAR PROTECTION..... 3

REPLACEMENT PARTS 4

ALTERATIONS..... 5

ABUSIVE HANDLING..... 5

ACCESSORIES 5

TRANSPORTING 5

STORAGE 6

CHAMBER SAFETY FLAG 6

LIABILITY..... 6

STATE BY STATE WARNINGS 7

FIREARM SAFETY RULES 11

BREAK-IN PROCEDURES 12

CYCLE OF FUNCTION..... 13

GENERAL OPERATION..... 15

Operation of Safety..... 15

Operation of the Bolt Catch..... 16

AMMUNITION..... 18

MAGAZINES..... 19

Loading 19

Inserting..... 19

Removing 20

LOAD AND FIRE WITH A MAGAZINE 20

LOAD AND FIRE WITHOUT MAGAZINE 22

UNLOAD..... 22

TO RELOAD THE FIREARM..... 23

EXTRACT AND EJECT A CHAMBERED CARTRIDGE 23



BORE OBSTRUCTION..... 24

CLEAR A MALFUNCTION 26

 Minimize Malfunctions 27

DISASSEMBLY 28

 Bolt Carrier Group..... 29

 Disassembly of the Bolt Carrier Group (BCG): 29

 Grip Removal..... 31

 Ambidextrous Safety/Selector Switch Removal..... 33

 Trigger Pack Removal & Disassembly 34

CARE AND CLEANING 36

REASSEMBLY..... 37

POF-USA FUNCTION TEST 38

WARRANTY POLICIES..... 41

MAINTENANCE AND WEAR PARTS..... 42

 “Wearable” or “Consumable” Parts..... 42

PARTS POLICY..... 43

TECHNICAL INFORMATION AND RECOMMENDATIONS..... 44

 Magazines 44

RENEGADE HANDGUARD..... 45

FASTENERS 46

DIAGRAMS 47



WELCOME TO POF-USA

Patriot Ordnance Factory, Inc. (POF-USA) is an American owned and operated small business with facilities headquartered in Phoenix, Arizona. All POF-USA firearms are American made. POF-USA firearms are engineered and tested to assure they meet the highest standards of durability and performance. Read this manual in its entirety before attempting to operate your POF-USA firearm. In addition, POF-USA recommends that you receive proper training in the handling of firearms prior to operating any firearm.

RIFLE DESCRIPTION

The Minuteman is our twist on the standard direct impingement carbine. Mount your favorite optic and the Minuteman is ready for the range or the field right out of the box. The minuteman features a 3.5lb match grade trigger, ambidextrous selector, multiple QD sling attachment points, and Renegade rail with oversized heatsink barrel nut.

The POF-USA Minuteman is a magazine fed, gas operated rifle available in 5.56 NATO and 300 Blackout. The Minuteman fires from a rotating locking closed bolt. It is available in semi-automatic rifle variants, as well as a pistol version. The operating system is a direct impingement gas system enabling optimum function under adverse conditions.

The POF-USA Minuteman is fitted with an aluminum handguard which provides a MIL-STD 1913 rail at the 12 o'clock position. There are multiple M-LOK™ mounting interfaces for accessories at the 3, 6 and 9 o'clock positions and has several sling attachment points.

EYE AND EAR PROTECTION

Before handling any firearm, ensure you and everyone close to you are wearing eye and ear protection. Always wear safety glasses that meet the requirements of American National Standards Institute (ANSI) z87.1 and ear plugs and " earmuff"-type protectors whenever you are shooting. Always make certain that people close to you are similarly protected. Unprotected eyes may be injured by powder, gas, carbon residue, lubricant, metallic particles, or similar debris that may emanate occasionally from any firearm in normal use. Without ear protection, repeated exposure to shooting noise may lead to cumulative, permanent hearing loss.



SAFETY WARNING

READ THIS ENTIRE MANUAL THOROUGHLY AND CAREFULLY PRIOR TO USING THIS FIREARM.

Please read the instructions and warnings contained in this manual BEFORE attempting to handle, load or utilize the POF-USA family of firearms. Even if you are familiar with the standard AR-10, AR-15, M-16, and/or M-4 family of firearms, you need to familiarize yourself with POF-USA firearms and their accessories before handling them in any manner. Failure to do so may result in damage to the firearm, bodily injury to the shooter or bystanders, or even death.

POF-USA firearms are designed and built to use factory manufactured cartridges only. Using hand-loaded, remanufactured, reloaded, or other non-standard ammunition may result in serious malfunction, damage to the firearm, or serious bodily injury to the shooter or bystanders, or even death. POF-USA, Inc. is not liable for any damage to the firearm, bodily injury to person(s), or damage to any property resulting from the use or misuse of any firearm. This manual should accompany the firearm at all times. A replacement copy can be obtained anytime by visiting our website at www.pof-usa.com.

The safety warnings are for the protection of the owner and operator of this POF-USA firearm as well as the safety of others. Disregarding information in this manual or failure to follow the basic rules of safe firearms handling can result in property damage, bodily injury and even death.

This operator's manual is designed to assist you in learning how to use and care for your POF-USA firearm properly.

Only when you are certain that you fully understand this manual, and can properly carry out its instructions, should you practice loading and firing your firearm with live ammunition. **Having a firearm in your possession is a full-time job; you cannot guess and you cannot forget. You must know how to use your firearm safely.**

If you have any doubts about your ability to handle or use this firearm safely, you should seek supervised instruction.

REPLACEMENT PARTS

Do not attempt to disassemble your POF-USA firearm beyond this manual's guidelines. Disassembly beyond the instructions in this manual is restricted to a certified POF-USA armorer or professional gunsmith. Failure to comply with these restrictions will void your warranty.

Warnings and instructions about the use of some POF-USA replacement parts, assemblies, and accessories may be described in literature accompanying the specific products. Read and carefully

follow those instructions. Such warnings and instructions are provided to assure the safe functioning of the firearm. Failure to heed them may result in improper functioning, damage to the firearm, and serious injury or death to the user or others.

ALTERATIONS

This POF-USA firearm was designed to function properly in its original condition. Unauthorized alterations can make it unsafe. Do not alter any part or add or substitute any parts or accessories not manufactured by POF-USA for this firearm. The addition of any parts or accessories beyond the user level of maintenance described in this manual is not authorized.

ABUSIVE HANDLING

POF-USA firearms incorporate effective mechanical safeties. However, like any mechanical device, exposure to abusive conditions may have a negative effect on these safety mechanisms and cause them to fail to work as designed. Do not subject your POF-USA firearm to any type of abusive handling. This includes dropping the firearm, or the firearm being struck by another object. Make sure you maintain control of your firearm at all times. If your firearm does suffer an abusive event such as previously described, do not attempt to use the firearm. Keep the firearm pointed in a safe direction, unload and clear the firearm of all ammunition immediately, and have it inspected by a certified POF-USA armorer or gunsmith prior to using the firearm.

A safe direction is defined as an area in which, if the firearm were to discharge, no property damage would occur, and no personal injury would result.

Intentional or repetitive abusive handling of any POF-USA firearm will void the manufacturer's warranty and may render the firearm unsafe.

ACCESSORIES

It is your responsibility to ensure that all accessories, such as slings and firearm-mounted lights, are compatible with this firearm and that the accessories do not interfere with the safe operation and handling of the firearm.

TRANSPORTING

When transporting your firearm, be sure the firearm is unloaded and cleared of all ammunition. It is your responsibility to familiarize yourself with, and observe, the laws of any state you will be traveling through with your firearm.

YOU MUST UNLOAD AND CLEAR THE FIREARM PRIOR TO TRANSPORTING. VERIFY THE MAGAZINE IS REMOVED. VISUALLY AND PHYSICALLY CONFIRM THE FIREARM IS UNLOADED AND CLEARED BEFORE TRANSPORTING. FAILURE TO ENSURE THE FIREARM IS UNLOADED AND CLEARED MAY RESULT IN UNINTENTIONAL DISCHARGE, CAUSING INJURY OR DEATH TO YOURSELF OR OTHERS, OR DAMAGE TO PROPERTY.



STORAGE

The only safe way to store your firearm is unloaded, cleared of all ammunition, and secure. Safe and secure storage is one of the most important responsibilities of any firearm owner. Store your unloaded firearm separate from your ammunition and in places inaccessible to children or unauthorized persons.

NEVER PLACE OR STORE ANY FIREARM IN SUCH A MANNER THAT IT MAY BE DISLODGED. FIREARMS SHOULD ALWAYS BE STORED SECURELY AND UNLOADED, AWAY FROM CHILDREN AND OTHER UNAUTHORIZED USERS. THE USE OF A LOCKING DEVICE OR SAFETY LOCK IS ONLY ONE ASPECT OF RESPONSIBLE FIREARMS STORAGE. FOR INCREASED SAFETY, FIREARMS SHOULD BE STORED UNLOADED AND LOCKED IN A LOCATION THAT IS BOTH SEPARATE FROM THEIR AMMUNITION AND INACCESSIBLE TO CHILDREN AND ANY OTHER UNAUTHORIZED PERSON.

CHAMBER SAFETY FLAG

Every POF-USA firearm is shipped with a chamber safety flag. The chamber safety flag prevents the chambering of a round when installed and provides a readily visible indication that the firearm's chamber is empty. The chamber safety flag is to be installed in the firearm's chamber at all times when the firearm is not in use.

LIABILITY

This product is classified as a FIREARM and is sold by POF-USA with the specific understanding that POF-USA shall not be responsible in any manner for malfunctioning of the firearm, physical injury, death, or property damage resulting in whole or in part from:

- Criminal or negligent discharge
- Improper, careless, or abusive handling
- Unauthorized modifications or parts replacement
- Defective, improper, hand-loaded, or reloaded ammunition
- Corrosion
- Neglect
- Other influences beyond our direct and immediate control

This limitation applies regardless of whether liability is asserted on the basis of contract, negligence, or strict liability (including any failure to warn). Under no circumstance shall POF-USA be liable for incidental or consequential damages such as loss of use of property, commercial loss, and loss of earnings or profits.



**PROTECT OUR CHILDREN
STORE YOUR FIREARMS RESPONSIBLY**

STATE BY STATE WARNINGS

Some states require by law that specified warning notices in “larger-than-normal” type be conspicuously included by the manufacturer, distributor, or retailer with firearms sold in that state. Since our products may be sold in those states, we include the following:

California:

 **WARNING**

Firearms must be handled responsibly and securely stored to prevent access by children and other unauthorized users. California has strict laws pertaining to firearms, and you may be fined or imprisoned if you fail to comply with them. Visit the Web site of the California Attorney General at <https://oag.ca.gov/firearms> for information on firearm laws applicable to you and how you can comply. Prevent child access by always keeping guns locked away and unloaded when not in use. If you keep a loaded firearm where a child obtains and improperly uses it, you may be fined or sent to prison.” If you or someone you know is contemplating suicide, please call the National Suicide Prevention Lifeline at 1-800-273 TALK (8255).

 **ADVERTENCIA**

Las armas de fuego deben manipularse de manera responsable y segura para evitar el acceso de niños y otros usuarios no autorizados. California tiene leyes estrictas relacionadas con armas de fuego, y usted puede ser multado o encarcelado si no las cumple. Visite el sitio web del fiscal general de california en <https://oag.ca.gov/firearms> para obtener información sobre las leyes de armas de fuego que son aplicables y cómo puede cumplirlas. Evite el acceso de niños manteniendo siempre las armas bloqueadas y descargadas cuando no estén en uso. Si mantiene un arma de fuego cargada donde un niño la puede obtener y la usa indebidamente, se le puede multar o enviar a prisión. Si usted o alguien que conoce está contemplando el suicidio, llame a la Línea Nacional de Prevención del Suicidio al 1-800-273 TALK (8255).

Connecticut:

“UNLAWFUL STORAGE OF A LOADED FIREARM MAY RESULT IN IMPRISONMENT OR FINE”



Florida:

“IT IS UNLAWFUL, AND PUNISHABLE BY IMPRISONMENT AND FINE, FOR ANY ADULT TO STORE OR LEAVE A FIREARM IN ANY PLACE WITHIN THE REACH OR EASY ACCESS OF A MINOR UNDER 18 YEARS OF AGE OR TO KNOWINGLY SELL OR OTHERWISE TRANSFER OWNERSHIP OR POSSESSION OF A FIREARM TO A MINOR OR A PERSON OF UNSOUND MIND”

Maine:

“ENDANGERING THE WELFARE OF A CHILD IS A CRIME. IF YOU LEAVE A FIREARM AND AMMUNITION WITHIN EASY ACCESS OF A CHILD, YOU MAY BE SUBJECT TO FINE, IMPRISONMENT OR BOTH. KEEP FIREARMS AND AMMUNITION SEPARATE. KEEP FIREARMS AND AMMUNITION LOCKED UP. USE TRIGGER LOCKS.”

Maryland:

“WARNING: Children can operate firearms which may cause death or serious injury. It is a crime to store or leave a loaded firearm in any location where an individual knew or should have known that an unsupervised minor would gain access to the firearm. Store your firearm responsibly!”

Massachusetts:

“WARNING FROM THE MASSACHUSETTS ATTORNEY GENERAL: This handgun is not equipped with a device that fully blocks use by unauthorized users. More than 200,000 firearms like this are stolen from their owners every year in the United States. In addition, there are more than a thousand suicides each year by younger children and teenagers who get access to firearms. Hundreds more die from accidental discharge. It is likely that many more children sustain serious wounds, or inflict such wounds accidentally on others. In order to limit the chance of such misuse, it is imperative that you keep this weapon locked in a secure place and take steps necessary to limit the possibility of theft or accident. Failure to take reasonable preventive steps may result in innocent



lives being lost, and in some circumstances may result in your liability for these deaths.”

“IT IS UNLAWFUL TO STORE OR KEEP A FIREARM, RIFLE, SHOTGUN, OR MACHINE GUN, IN ANY PLACE UNLESS THAT WEAPON IS EQUIPPED WITH A TAMPER-RESISTANT SAFETY DEVICE OR IS STORED OR KEPT IN A SECURLY LOCKED CONTAINER.”

New Jersey:

“IT IS A CRIMINAL OFFENSE TO LEAVE A LOADED FIREARM WITHIN EASY ACCESS OF A MINOR.”

New York:

“THE USE OF A LOCKING DEVICE OR SAFETY LOCK IS ONLY ONE ASPECT OF RESPONSIBLE FIREARM STORAGE. ALL FIREARMS SHOULD BE STORED UNLOADED AND LOCKED IN A LOCATION THAT IS BOTH SEPARATE FROM THEIR AMMUNITION AND INACCESSIBLE TO CHILDREN AND ANY OTHER UNAUTHORIZED PERSONS. NEW YORK CITY LAW PROHIBITS, WITH CERTAIN EXCEPTIONS, ANY PERSON FROM ACQUIRING MORE THAN ONE FIREARM, OR MORE THAN ONE FIREARM OR SHOTGUN, WITHIN A 90-DAY PERIOD.”

North Carolina:

Any person who resides in the same premises as a minor, owns or possesses a firearm, and stores or leaves the firearm (i) in a condition that the firearm can be discharged and (ii) in a manner that the person knew or should have known that an unsupervised minor would be able to gain access to the firearm, is guilty of a Class 1 misdemeanor if a minor gains access to the firearm without the lawful permission of the minor’s parents or a person having charge of the minor and the minor:

- (1) Possesses it in violation of G.S. 14-269.2(b)
- (2) Exhibits it in a public place in a careless, angry, or threatening Manner;
- (3) Causes personal injury or death with it not in self defense; or
- (4) Uses it in the commission of a crime.



Texas:

“IT IS UNLAWFUL TO STORE, TRANSPORT, OR ABANDON AN UNSECURED FIREARM IN A PLACE WHERE CHILDREN ARE LIKELY TO BE AND CAN OBTAIN ACCESS TO THE FIREARM.”

Wisconsin:

“IF YOU LEAVE A LOADED FIREARM WITHIN THE REACH OR EASY ACCESS OF A CHILD YOU MAY BE FINED OR IMPRISONED OR BOTH IF THE CHILD IMPROPERLY DISCHARGES, POSSESSES, OR EXHIBITS THE FIREARM.”

As a responsible firearm owner it is your responsibility to be aware of any local, state, or federal laws governing the lawful ownership of firearms. The above is not all inclusive of all states and is subject to change. Please check with your local retailer, state police, and local law enforcement for current regulations in your area.

Visit the NRA website (www.nra.org) or the BATFE website (www.atf.gov) for further information.

.....



This product can expose you to chemicals including Cumene which is known to the state of California to cause cancer, and Trichloroethylene which is known to the state of California to cause birth defects and/or other reproductive harm. For more information go to www.P65Warnings.co.gov



Este producto puede exponer a sustancias químicas que incluyen al Cumeno, que el estado de California conoce como causante de cáncer, y el Tricloroetileno, que el estado de California conoce como causante de defectos de nacimiento u otros daños reproductivos. Para obtener más Información, vaya a www.P65Warnings.ca.gov



DISCHARGING FIREARMS IN POORLY VENTILATED AREAS, CLEANING FIREARMS, OR HANDLING AMMUNITION MAY RESULT IN EXPOSURE TO LEAD AND OTHER SUBSTANCES KNOWN TO CAUSE BIRTH DEFECTS, REPRODUCTIVE HARM, AND OTHER SERIOUS PHYSICAL INJURY. MAINTAIN ADEQUATE VENTILATION AT ALL TIMES. WASH HANDS THOROUGHLY AFTER EXPOSURE. SHOOTING OR CLEANING FIREARMS MAY EXPOSE YOU TO LEAD.



FIREARM SAFETY RULES

1. **Treat all firearms as if they are loaded.** Always assume that a firearm is loaded even if you think it is unloaded. Every time a firearm is handled, for any reason, check that it is unloaded. If you are unable to check a firearm to see if it is unloaded, leave it alone and seek help from someone more knowledgeable about firearms.
2. **Keep the firearm pointed in the safest possible direction.** Always be aware of where a firearm is pointing. A "safe direction" is one where an accidental discharge of the firearm will not cause injury or damage. Only point a firearm at an object you intend to shoot. Never point a firearm toward yourself or another person.
3. **Keep your finger off the trigger until you are ready to shoot.** Always keep your finger off the trigger and outside the trigger guard until you are ready to shoot. Even though it may be comfortable to rest your finger on the trigger, it is also unsafe. If you are moving around with your finger on the trigger and stumble or fall, you may inadvertently pull the trigger. Sudden loud noises or movements can result in an accidental discharge because there is a natural tendency to tighten the muscles when startled.
4. **Know your target, its surroundings and beyond.** Check that the areas in front of and behind your target are safe before shooting. Be aware that if the bullet misses or completely passes through the target, it may strike a person or object. Identify the target and make sure it is what you intend to shoot. If you are in doubt, DON'T SHOOT! Never fire at a target that is only a movement, color, sound, or unidentifiable shape. Be aware of all the people around you before you shoot.
5. **Know how to properly operate your firearm.** It is important to become thoroughly familiar with your firearm. You should know its mechanical characteristics including how to properly load, unload and clear a malfunction from your firearm. Obviously, not all firearms are mechanically the same. Never assume that what applies to one make or model is applicable to another. You should direct questions regarding the operation of your firearm to your firearms dealer, or contact the manufacturer directly.
6. **Store your firearm safely and securely to prevent unauthorized use.** Firearms and ammunition should be stored separately. When the firearm is not in your hands, you must still consider safety. Use a safety device on the firearm, such as a trigger lock or cable lock, so it cannot be fired. Store it unloaded in a locked container, such as a lock box or a firearm safe. Store your firearm in a different location than the ammunition. For maximum safety, you should use both a locking device and a storage container.
7. **Never use Alcohol, Over the Counter, Prescription, or other drugs before or while handling a firearm.** These substances are likely to impair normal mental or physical bodily functions and must not be used before or while handling or shooting firearms.



BREAK-IN PROCEDURES

Please read "Breaking In Your New Firearm" and watch the videos under "Cleaning Videos", both of which can be found on our technical page at POF-USA.COM. Make sure you clean and lubricate your firearm using the techniques shown in the video, especially the cleaning of the chamber.

Breaking In Your New Firearm

1. Thoroughly clean the chamber of your new firearm, and clean after every shooting session. Check out our links on the technical page for cleaning procedures and tips.
<http://pof-usa.com/technical-support/>
2. Generously lubricate the bolt carrier group (BCG) with your favorite firearm lubricant. As your firearm breaks in less lubrication will be needed and after a few hundred rounds a light wipe will be sufficient.
3. Put a little lubricant in the buffer tube.
4. There is no break-in required for the barrel, simply clean it at the end of each shooting session.
5. POF-USA only recommends the use of factory new ammo and cannot offer advice or tips regarding hand loading or re-loaded ammo.



CYCLE OF FUNCTION

There are eight steps in the cycle of function of the POF-USA Minuteman which begin after a loaded magazine is inserted into the firearm.

FEEDING

As the bolt carrier is released from its rearward position, the carriage assembly moves forward allowing the lower lugs of the bolt to make contact with the rear of the cartridge as it sits in the magazine. The cartridge is stripped from the magazine and begins forward movement toward the chamber.

CHAMBERING

As the bolt moves forward, the bolt locking lugs move forward into the barrel extension. The ejector is compressed against the left side of the cartridge head. The extractor snaps over the rim of the cartridge case.

LOCKING

The movement of the bolt and the cartridge is stopped by the chamber. The bolt carrier continues forward movement until it is stopped by contact with the rear face of the barrel extension. As the carrier goes through the last portion of movement, the bolt is rotated to the left, through the action of the cam pin. The bolt lugs engage the barrel extension lugs to lock the bolt into the barrel extension.

FIRING

The selector is rotated to the semi position. The trigger is pressed releasing the hammer. The hammer spring drives the hammer forward striking the firing pin. The firing pin strikes the cartridge primer, causing detonation.

UNLOCKING

As the bullet passes the gas port in the barrel, a small amount of gas is bled off, traveling up through the gas port and into the gas block. The gas is regulated by the gas valve and is based on the type of ammunition being fired. This gas acts upon the piston to move the recoil assembly to the rear. The recoil assembly transfers its energy to the carrier assembly setting it in motion. The rearward movement of the carrier causes the bolt cam pin to rotate the bolt to the unlocked position.

EXTRACTION

As the bolt carrier assembly moves rearward, the spent case is pulled free from the chamber by the extractor. The twisting motion of the bolt aids in the extraction from the chamber.

EJECTION

The extractor continues to grip the rim of the spent case on the right side. The ejector applies forward pressure to the left side of the case. As the expended case clears the chamber and the barrel extension, it is flipped out through the ejector port on the right side of the receiver.

COCKING

The rearward movement of the bolt carrier forces the hammer down into the receiver and compresses the hammer spring, cocking the hammer into the firing position.



GENERAL OPERATION

Operation of Safety

The manual safety mechanism is located above the trigger on the left side (and right if ambidextrous equipped) of the lower receiver. The safety can be moved to “SAFE”  anytime the hammer is cocked. When the safety is on, it blocks the trigger. The safety should always be kept in the “SAFE” position when loading or unloading the firearm, and at all times unless firing. The firearm is in the “SAFE” position when the lever is in a horizontal position. (See Figures 1 & 2 below).



Figure 1
“SAFE”



Figure 2
“FIRE”

Keep the safety on unless firing. Always move the safety fully to its intended position and check it. The safety is not “ON” unless it is completely in position. Never depend on a safety mechanism or any mechanical device to justify careless handling or permitting the firearm to point in an unsafe direction. The only “safe” firearm is one in which the bolt is open, the chamber is empty, there is no magazine in it, and the muzzle is pointed in a safe direction.

KNOW HOW TO USE THE SAFETY

Operation of the Bolt Catch

POF-USA firearms are designed so that the bolt will remain open after the last shot has been fired, provided there is a correctly functioning magazine in the firearm. When the magazine is empty, the magazine follower engages the bolt catch, which retains the bolt carrier group (BCG) in the rearward position.

WARNING: The bolt catch is NOT a safety device. It should not be used to hold back the bolt when there are cartridges in the magazine. A slight jar to the butt end of the firearm can cause the bolt catch to disengage allowing the BCG to move forward and feed a cartridge into the chamber.

The bolt catch should be used to hold the bolt in its rearward position only when the chamber is empty, and an empty magazine is in place.

To hold the bolt carrier group (BCG) open:

Put the safety on "SAFE". 

1. Pull the charging handle all the way to the rear.
2. Depress the bottom part of the bolt catch and allow the bolt carrier to move forward until it stops. **(See Figure 3)**



Figure 3

To release the bolt carrier, allowing the bolt to move forward, KEEP SELECTOR ON SAFE and either:

1. Remove the magazine; draw the charging handle to the rear and release. Allow the handle to spring forward freely. Do not “ride” the charging handle or otherwise restrict the forward motion.
2. Push the top part of the bolt catch toward the lower receiver. **(See Figure 4)**



Figure 4

CAUTION: The bolt carrier group (BCG) is under heavy spring tension and can injure fingers when it slams shut. Do not place your fingers in the action or in front of the charging handle when releasing the bolt from the bolt catch.

AMMUNITION

POF-USA only recommends the use of factory new ammunition loaded in accordance with U.S. industry practice and cannot offer any advice or tips regarding hand loaded or reloaded ammunition. Damages due to high pressure, reloaded, or non-standard ammunition is not covered under warranty.

Use only high-quality, original, factory-manufactured ammunition. Do not use cartridges that are dirty, wet, corroded, bent, or damaged. Do not oil cartridges. Do not spray aerosol-type lubricants, preservatives, or cleaners directly onto cartridges or where excess spray may flow into contact with cartridges. Lubricant or other foreign matter on cartridges can cause potentially dangerous ammunition malfunctions. Use only ammunition of the caliber for which your firearm is chambered. The proper caliber is permanently engraved on the barrel of the firearm; never attempt to use ammunition of any other caliber.

Death, serious injury and damage can result from the use of wrong ammunition; bore obstructions, powder overloads, or incorrect cartridge components. Always wear eye protection and hearing protection while discharging your firearm.

ONLY USE FACTORY AMMUNITION LOADED TO U.S. INDUSTRY STANDARDS

POF-USA SPECIFICALLY DISCLAIMS ANY RESPONSIBILITY FOR ANY DAMAGE OR INJURY WHATSOEVER OCCURRING IN CONNECTION WITH, OR AS A RESULT OF, THE USE IN POF-USA FIREARMS OF FAULTY, NON-STANDARD, "REMANUFACTURED", HAND LOADED (RELOADED) AMMUNITION, OR OF CARTRIDGES OTHER THAN THOSE FOR WHICH THE FIREARM WAS ORIGINALLY CHAMBERED.

WARNING-LEAD EXPOSURE

Discharging firearms in poorly ventilated areas, cleaning firearms, or handling ammunition may result in exposure to lead and other substances known to the State of California to cause birth defects, reproductive harm, and other serious physical injury. Wash hands thoroughly after exposure.

SHOOTING OR CLEANING GUNS MAY EXPOSE YOU TO LEAD

MAGAZINES

5.56 NATO and 300 AAC Blackout caliber firearms are normally supplied with one 30 round magazine. Firearms supplied to states with magazine restrictions are shipped with the appropriate magazine based upon the state restriction.

DAMAGED, NON-STANDARD, OR IMPROPERLY ASSEMBLED MAGAZINES

SHOULD NOT BE USED – THEY MAY CAUSE THE FIREARM TO MALFUNCTION

Loading

Use only clean, dry ammunition of the proper caliber manufactured to U.S. Industry specifications, in good condition. With the short end of the magazine facing forward, place a round between the feed lips of the magazine with the bullet forward. Press the round down until it is held by the magazine feed lips. Place the next round and repeat until the desired number of cartridges are loaded. **(See Figure 5)**



Figure 5

Inserting

The magazine may be inserted with the bolt carrier either closed or open (see Operation Of The Bolt Catch on page 16). More force will be required to insert the magazine with the bolt in the closed position to overcome the bolt carrier group.

1. Hold the magazine as shown and insert it into the magazine well until it is seated/latched. **(See Figure 6)**
2. Check to assure it is securely latched in place by pulling on the magazine, it should not come out.



Figure 6

Removing

To remove the magazine, push the magazine catch button towards the lower receiver from the right side (**See Figure 7**) until the magazine drops out of the magazine well. Avoid letting the magazine drop to the ground, this will prevent the possibility of damage to the magazine and minimize the possibility of magazine related malfunctions. If the magazine is full of ammunition, you may need to assist its removal by applying a slight downward tug on the magazine body until it clears the magazine well.



Figure 7

LOAD AND FIRE WITH A MAGAZINE

Safe firearm handling should be practiced with an unloaded firearm until you can perform each of the following steps with skill and confidence. Please read this manual completely prior to operating your POF-USA firearm.





1. Be certain the muzzle is pointed in a safe direction.
2. Before inserting a loaded magazine, engage the bolt catch so that the bolt carrier is held open.
3. Verify the chamber is empty. Move the safety selector to the “ON” or “SAFE”  position.
4. Insert a loaded magazine into the magazine well and release the bolt catch by either depressing the pad on the left side or draw the charging handle to the rear and release. Allow the handle to spring forward freely. Do not “ride” the charging handle or otherwise restrict the forward motion. A cartridge will be stripped from the magazine and chambered by the motion of the bolt carrier moving forward.

WARNING: *If cartridges do not feed smoothly from the magazine into the chamber, then do not use the firearm until the problem is corrected (See CLEAR A MALFUNCTION, Page 26)*

5. The firearm is now cocked, and a cartridge is chambered. Visually check to be certain the safety is in the "ON" or in the "SAFE"  position, and the firearm is pointed in a safe direction.

WARNING: DO NOT TOUCH THE TRIGGER UNTIL YOU ARE ACTUALLY READY TO FIRE.

KEEP THE SAFETY "ON"  UNLESS ACTUALLY FIRING

6. When you are ready to fire, move the safety to the "FIRE"  position.
7. The firearm will fire one shot each time the trigger is pulled until the magazine is empty. A portion of the gas produced by the combustion of the powder in the cartridge is used to cycle the bolt carrier. This process ejects the fired cartridge case, re-cocks the firearm and loads a new cartridge from the magazine into the chamber.
8. Immediately following the firing of the cartridge and if no other cartridges are to be fired, put the safety in the "SAFE"  position while the firearm is still pointed in a safe direction. The safety should always be moved to the "SAFE"  position as soon as firing is completed, and it should be on "SAFE"  at all times except when the firearm is on target and being fired.
9. When the last cartridge in the magazine has been fired, the bolt catch should automatically engage and hold the bolt carrier in the rearward open position.

IF DROPPED OR STRUCK WITH THE SAFETY "OFF", THE FIREARM MAY FIRE.

KEEP THE CHAMBER EMPTY UNLESS ACTUALLY FIRING!

KEEP THE SAFETY ON THE "SAFE"  POSITION UNLESS ACTUALLY FIRING!

A FIREARM MAY FIRE IF DROPPED.

LOAD AND FIRE WITHOUT MAGAZINE

Your firearm can be used as a single shot in the absence of a magazine or for training purposes. To do so, follow steps 1 & 2 above then manually load a cartridge into the chamber. Then follow steps 4 & 5 (disregard magazine). During this procedure the bolt will not automatically lock back after the cartridge is fired and ejected. Engage the safety between shots.

CAUTION:

It is not recommended or advised to chamber the same round of ammunition multiple times. Doing so may induce a slam fire scenario or a catastrophic cartridge failure.



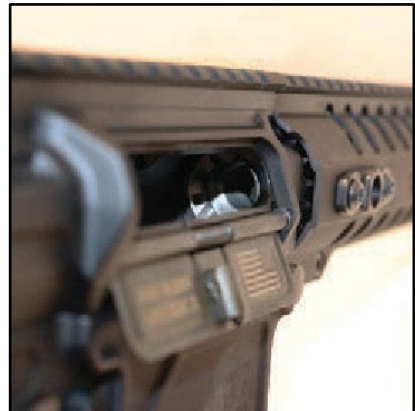

UNLOAD

WARNING: This sequence must be followed exactly. Failure to do so can result in the rifle's chamber becoming unintentionally loaded with a cartridge!

1. Keep the muzzle pointed in a safe direction at all times and keep your fingers outside the trigger guard. Rotate the safety to the "SAFE"  position.
2. Remove the magazine. **REMEMBER** that even though the magazine has been removed, a cartridge remaining in the chamber can still be fired!
3. Pull the charging handle all the way to the rear, extracting and ejecting the cartridge in the chamber.
4. When the bolt carrier is fully retracted, lock the bolt carrier back using the appropriate method described on page 16.
5. Always visually double check the chamber to be certain it is empty.
6. The only "safe" firearm is one in which the bolt carrier is open, the chamber and magazine are empty, and the muzzle is pointed in a safe direction.



TO RELOAD THE FIREARM

1. Firing all cartridges in the magazine and the chamber will cause the bolt carrier to automatically lock open. Keep the rifle pointed in a safe direction. Put the safety in the “SAFE”  position. Removal of the magazine can be accomplished by pressing inward on the magazine catch button with the thumb or forefinger. The magazine should fall free of the rifle of its own weight. To avoid the possibility of damage to the magazine, do not let it fall to the ground.
2. Insert a loaded magazine. **WARNING:** The bolt catch is held in place by friction between the bolt face and the rear surface of the bolt catch. Therefore, when there is a loaded magazine in place and the rifle is jarred, the bolt can release and chamber a cartridge.
3. Release the bolt carrier by the methods described on page 17. A cartridge will be chambered when the bolt carrier shuts. **WARNING:** The rifle is ready for instant use once the bolt carrier moves forward. If the rifle is not to be fired immediately, keep the safety on “SAFE” . When you are ready to fire, move the selector to the “FIRE”  position and resume firing, putting the safety back on “SAFE”  when you cease firing, even for a moment.

EXTRACT AND EJECT A CHAMBERED CARTRIDGE

When the rifle is fired, the same gas pressure that drives the bullet forward bleeds through the gas port into the gas block, gas tube, and into the gas key to push the bolt carrier to the rear. This action causes extraction and ejection of the fired cartridge case. If a cartridge fails to fire or if the shooter wishes to eject the chambered cartridge manually, follow the procedure described in “UNLOAD” on page 22. When the charging handle is operated, there can be a failure to extract the cartridge from the chamber, or a failure to eject the cartridge clear of the rifle. These failures usually are the result of the charging handle not being pulled rearward forcefully. If this situation occurs, the user must:

1. Visually check the chamber after opening the action. If the charging handle is not vigorously retracted, the extracted cartridge can be “ejected” into the magazine area.
2. If an empty magazine is in the rifle when the charging handle is being retracted, the cartridge may drop on top of the magazine or remain held to the bolt face by the extractor. Then, when the bolt carrier goes forward, the cartridge will be chambered again!
3. Thoroughly clean the chamber and the extractor as often as necessary.

WARNING: ALWAYS REMOVE THE MAGAZINE BEFORE CLEARING THE CHAMBER. YOU MUST VISUALLY AND PHYSICALLY CHECK TO ENSURE THAT NO CARTRIDGES REMAIN IN THE FIREARM.

BORE OBSTRUCTION

Immediately stop shooting, keep the firearm pointed in a safe direction whenever:

- You have difficulty in, or feel unusual resistance in, chambering a cartridge.
- A cartridge misfires (does not go off).
- The mechanism fails to extract a fired cartridge case.
- Unburned grains of propellant powder are discovered spilled in the mechanism.
- A shot sounds weak or abnormal. It is possible that a bullet is lodged part way down the barrel.

Firing a subsequent bullet into the obstructed barrel can damage the firearm and cause serious injury to the shooter or to bystanders.



Firearms which are chambered for small caliber high-velocity cartridges are particularly susceptible to damage from firing when the bore is obstructed. Excess oil, grease, or water may form an obstruction which may cause damage and injury. If you suspect that your rifle may have excess oil, grease, or other contaminants in the barrel, or if it may have been exposed to humid conditions (which may cause condensation), or to rain or snow which might have entered the bore, open the bolt carrier and clean out the barrel. Inspect the bore visually to be sure that it is perfectly clear.

A firearm user should recognize that a lodged bullet is a common form of bore obstruction. The following information on how a bullet may become lodged in the bore, and how it should be removed, deserves careful reading and understanding.

Bullets can become lodged in the barrel when:

1. The cartridge contains no powder, insufficient powder, or the powder fails to ignite and only the primer charge ignites, producing insufficient force to propel the bullet out of the bore.
2. Extracting a cartridge from the chamber (unloading). If the bullet is not crimped tightly enough in the cartridge case, the bullet may stick in the bore, with only the case being extracted.

When either of the above described (1 or 2) situations occur, proceed as follows *with the firearm pointing in a safe direction*:

1. If the firearm is cocked, move the safety to the "SAFE"  position.
2. Remove the magazine from the firearm.
3. Retract the charging handle and lock it in the open position. Retracting the charging handle should remove the cartridge case. Be certain the safety is in the "SAFE"  position.
4. Check the chamber to be certain there is no cartridge case in it – if there is, extract it before proceeding with steps 5 and 6.

Always check the bore for an obstruction if you experience difficulty in chambering a cartridge, a failure to extract, have a misfire, or the firearm does not make a normal report on firing.



5. After making sure the chamber is clear and the magazine is removed, close the bolt, disengage the take down pin, remove the bolt and carrier as directed under the “Disassembly” section on page 28. **Inspect** the bore visually and with a rod as necessary.
6. If the bore is obstructed, insert a proper size cleaning rod (without a tip or brush) into the bore from the muzzle and dislodge and remove the bullet. If the bullet does not readily dislodge, it may be necessary to lightly tap the handle end of the cleaning rod. If such efforts fail to dislodge the bullet, take the firearm to a gunsmith.
7. Inspect the bore to be certain it is free of unburned powder particles or any other debris. At the same time clean the magazine, the magazine well, and other areas of the mechanism of unburned powder grains.

If the bullet cannot be dislodged by tapping it with a cleaning rod, take the firearm to a gunsmith or certified POF-USA Armorer.

DO NOT ATTEMPT TO REMOVE A LODGED BULLET USING A BLANK CARTRIDGE, A CARTRIDGE FROM WHICH THE BULLET HAS BEEN REMOVED, OR BY ANY MEANS OTHER THAN THE USE OF THE PROPER SIZE CLEANING ROD AND REASONABLE FORCE APPLIED TO THE ROD. BE CERTAIN ALL LOOSE POWDER HAS BEEN REMOVED FROM THE BORE AND ACTION BEFORE INTRODUCING THE ROD INTO THE BORE. NEVER TRY TO SHOOT OUT A BORE OBSTRUCTION!

CLEAR A MALFUNCTION

If you experience a malfunction, study the situation to determine the nature of the malfunction and how best to clear it. Any auto-loading firearm may occasionally malfunction. If it does:

1. Be certain the muzzle is pointed in a safe direction and the safety is in the “SAFE”  position.
2. When attempting to free a stuck cartridge, do not use any type of tool that is likely to act as a “firing pin” and discharge the cartridge should the tool impact on the primer. Never use a cartridge as a “tool.”
3. After clearing a malfunction, inspect the firearm mechanism to determine if dirt or debris might be the cause of the problem. Excess lubricant or grease can cause cartridges to feed sluggishly. An accumulation of grease, dirt or powder grains in the magazine can contribute to cartridge feeding problems.
4. After clearing a malfunction, inspect all cartridges that have been removed from the firearm. Safely dispose of any cartridges which are dented or nicked or have bullets that are loose or improperly positioned in the cartridge case.
5. If it appears that the gun and magazine are not at fault and that the malfunction was caused by the type of cartridge being used, then try another type or brand of cartridge.
6. If the above procedures do not result in a smooth and reliable feeding firearm, do not use the firearm until it feeds cartridges smoothly and reliably. The firearm should be returned directly to POF-USA for repair. Contact TECHNICAL@POF-USA.COM for packing and shipping information.
7. If a cartridge or shell is caught between the bolt carrier and receiver, put the safety on SAFE” , retract the bolt carrier using the charging handle, and lock it in the open position using the bolt catch. Remove the magazine; then remove the stuck case.
8. If a fired cartridge case is in the chamber, use a cleaning rod to knock it out.
9. If an unfired cartridge is stuck in the chamber, keep the muzzle pointed in a safe direction with the safety in the “SAFE”  position. Close the bolt, disengage the take down pin, remove the bolt and carrier, and remove the unfired cartridge from the chamber end rather than trying to dislodge it with a cleaning rod inserted from the muzzle. Use a 3/16” brass rod which has one end shaped like a screwdriver tip. Insert the tip in the extractor groove of the cartridge. Use the face of the ejection port as a fulcrum and carefully pry out the cartridge. Be careful not to strike the primer area of the live cartridge! Vigorously brush-clean the chamber with solvent after clearing any malfunction involving the chamber.



Examine fired cartridge cases. If fired cases have bulged heads or show splits on any part of the case, stop using that ammunition. If the problem persists with different types of ammunition, contact technical@pof-usa.com.

Minimize Malfunctions

Auto-loading firearms of all makes and types occasionally malfunction when a cartridge fails to feed from the magazine to the chamber, or when a cartridge (or fired case) fails to properly extract and eject. To minimize the possibility of such occurrences the gun user should:

1. Use ammunition of the correct caliber and type which is loaded to industry specifications. Avoid reloads, remanufactured cartridges, and cartridges that are dirty, corroded, or deformed.
2. Clean and lubricate the gun in accordance with the instructions in this manual and the instructional videos on the POF-USA website.
3. If the mechanism shows signs of not functioning correctly, or if a part is damaged or broken, do not use the firearm. Have it inspected and repaired.
4. Use only high-quality magazines and carefully load the magazine. Do not exceed the stated magazine capacity.
5. Do not “ride” the charging handle when chambering a cartridge from the magazine. The bolt carrier should be permitted to snap forward under the full force of the buffer spring. If a cartridge does not fully chamber, use the forward assist no more than twice to force the bolt carrier closed. If the cartridge is still not chambered completely, the round should be cleared as a malfunction.
6. To minimize the probability of an unfired cartridge causing a malfunction should it “fall back” onto the magazine, remove the magazine *before* retracting the carrier. When extracting an unfired cartridge, tip the right side of the rifle towards the ground so that gravity will assist the cartridge to fall clear of the ejection port. Always retract the charging handle briskly when extracting a live cartridge. Take care to see that a cartridge is not forcibly ejected against a surface where the primer might be set off.

DISASSEMBLY

1. With the rifle pointing in a safe direction, safety in the “SAFE”  position, remove the magazine by pushing the magazine catch button inward to release the magazine, while drawing the magazine down.
2. Pull the charging handle all the way to the rear and ensure the rifle is clear and unloaded. Release the charging handle and ensure the bolt is closed. Make sure the safety is in the “SAFE”  position.

NOTE: Hammer must be cocked to place the selector in the “SAFE”  position. Again, be sure the chamber is empty!



3. With the Bolt Carrier Group (BCG) forward into battery press the rear take down pin located on the left side of the lower receiver to the right. From the right side of the rifle, pull the pin outward until the detent stops any additional travel.



4. Tilt the upper receiver forward on the front pivot pin, remove the bolt carrier group (BCG) and charging handle from the upper receiver.



5. The user may remove the upper receiver from the lower receiver by pushing the pivot pin on the left side of the lower receiver to the right. Reach to the right-hand side of the lower receiver and pull the pivot pin to the right until the detent stops any additional travel.

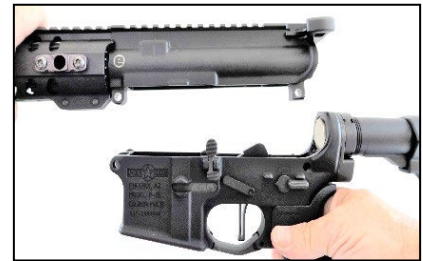

6. Lift the upper receiver off of the lower receiver.

Bolt Carrier Group

Remove the Bolt Carrier Group (BCG) and the charging handle from the upper receiver by sliding them to the rear. Align the tabs of the charging handle with the corresponding cut in the upper receiver. Once aligned, you can lift the charging handle into the center bore and out the rear of the upper receiver. You can now set the upper receiver aside.



Remove the BCG



Remove the charging handle

Disassembly of the Bolt Carrier Group (BCG):

Retrieve the bolt carrier group (BCG).

1. Remove the firing pin retaining pin by pulling it through the left side of the carrier.

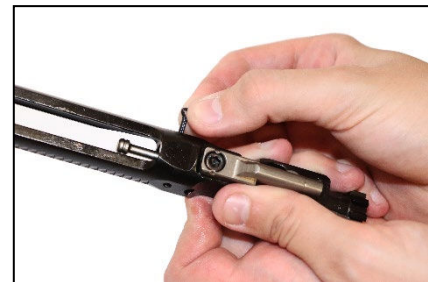

Remove the firing pin out the back of the bolt and bolt carrier.



2. The roller cam pin can now be removed from the bolt carrier group.



3. The bolt can now slide out the front of the bolt carrier.



4. The BCG is now disassembled down to a user level and is ready to clean.

Note: When cleaning the BCG be sure to clean the ejector, extractor, bolt face, and the locking lugs of the bolt.

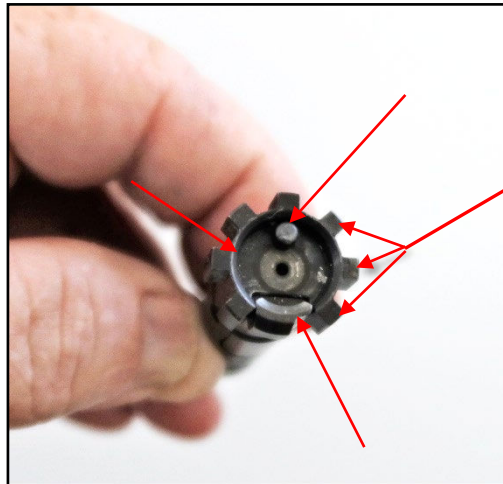

Grip Removal

1. Remove grip screw using a 3/16" Allen wrench.
2. Carefully begin removing the grip by pulling downward on it, making sure not to bend the safety detent spring located at the top right corner of the grip.
3. Remove the safety detent spring from the grip, and then retrieve the safety detent from the right side of the receiver.

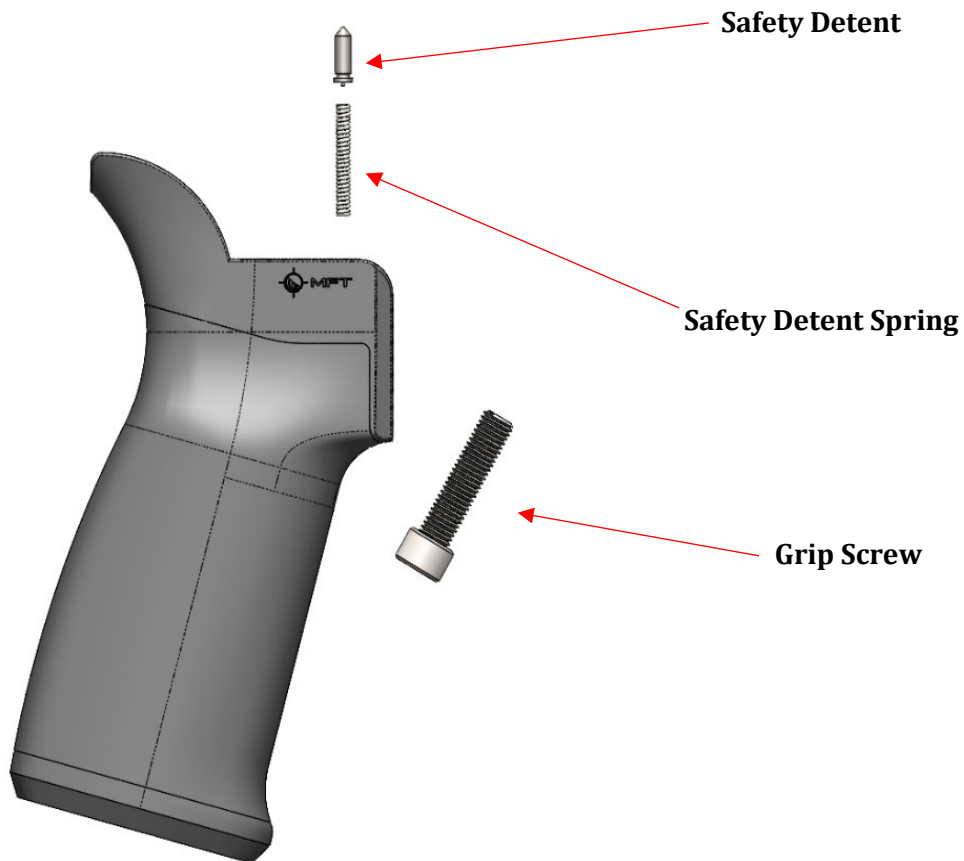

DISCLAIMER:

The following disassembly processes should only be performed by a certified POF-USA Armorer or gunsmith.

You **MUST** perform the Function test, as described on pages 38, 39, and 40, to ensure the trigger was properly cleaned and assembled correctly after every cleaning session.

POF-USA parts may only be installed in conjunction with: 1) Other parts that were designed and/or sold by POF-USA or 2) Parts that adhere to the safety and functional dimensional requirements of the M16, M4 carbine, or any subsequent variant military specifications or data packages.

Ambidextrous Safety/Selector Switch Removal

1. Begin by removing the grip as described in the previous section. With the hammer in the cocked position, remove the ambidextrous (right side) Safety/Selector screw using a 1/16" Allen or a T10 Torx wrench.
2. Remove the ambi-selector cap.
3. Unscrew the two retaining screws for the KNS Trigger Pin using two T8 Torx wrenches. Remove the two retaining plates.
4. Remove the KNS Trigger Pin and Hammer Pin to free the trigger assembly for movement.
5. Tilt the trigger to the rear to allow proper clearance for the body of the Safety/Selector to be removed out the left side of the receiver.
6. Remove the Safety/Selector body out the left side of the receiver.
7. To reinstall the Safety/Selector perform these steps in reverse. It is important that you install the selector before installing the trigger and hammer pins. You may break the tail of the trigger if you try to force the selector in after the trigger and hammer pins have been installed.

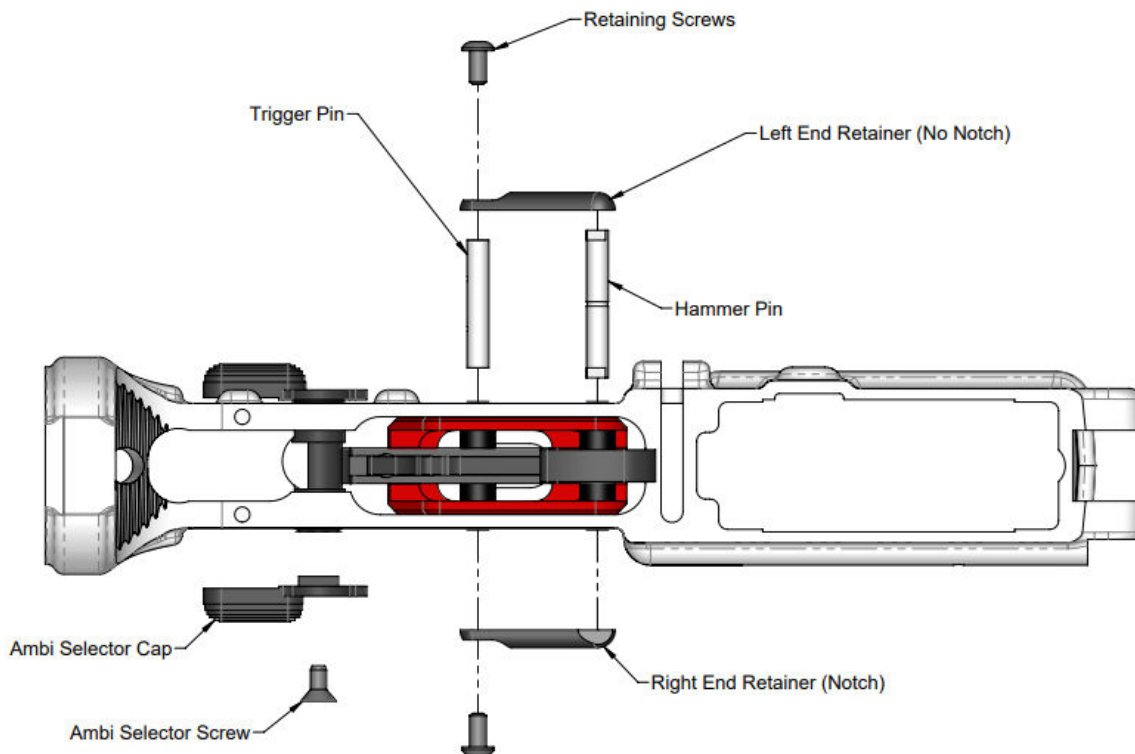

Trigger Pack Removal & Disassembly

WARNING: Trigger components must be cleaned and maintained every 250 rounds, or after every shooting session, whichever comes first. Failure to properly clean and maintain the firearm and its components according to the cleaning procedure found in the support section of www.pof-usa.com can lead to damage to the firearm, bodily injury or death to the shooter or bystanders.

NOTE: The following images show the hammer and trigger springs in the compressed, assembled state. Springs will revert to their natural resting state once removed from the trigger housing.

- 1.) Begin by removing the pistol grip, KNS Trigger Pin, KNS Hammer Pin, and safety selector as described on page 31 and page 33. You should now be able to lift the trigger pack out of the lower receiver.
- 2.) If the hammer is down in the trigger pack, place your thumb over the hammer and grip the trigger pack. Release pressure on the hammer spring by pulling the trigger and slowly allowing the hammer to reach its resting point.

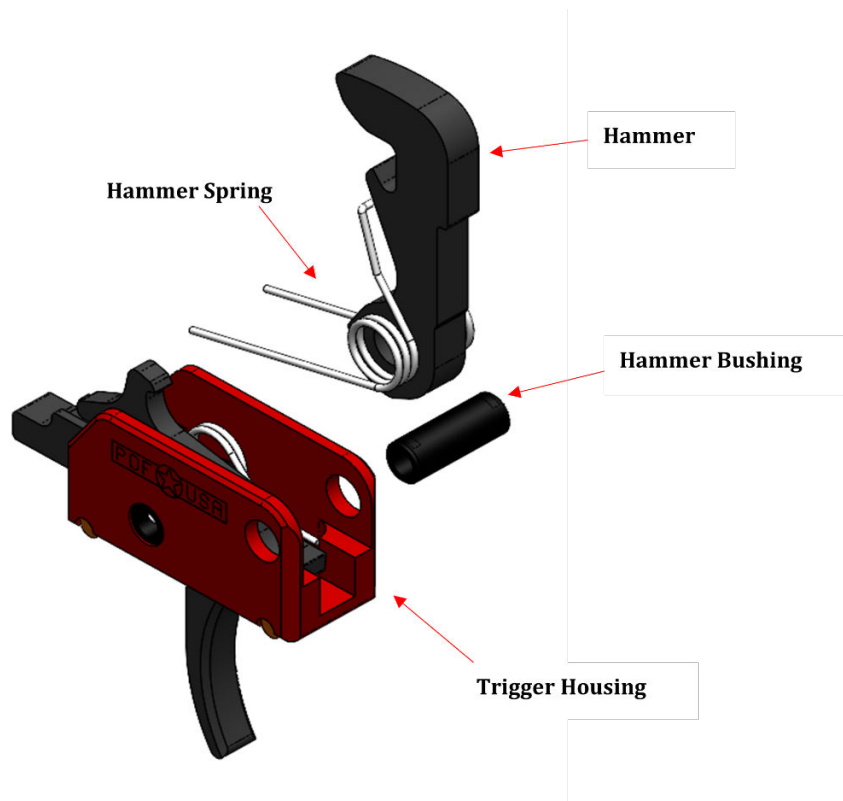

- 3.) Press the hammer bushing through the trigger housing, then lift the hammer and hammer spring out of the trigger housing.

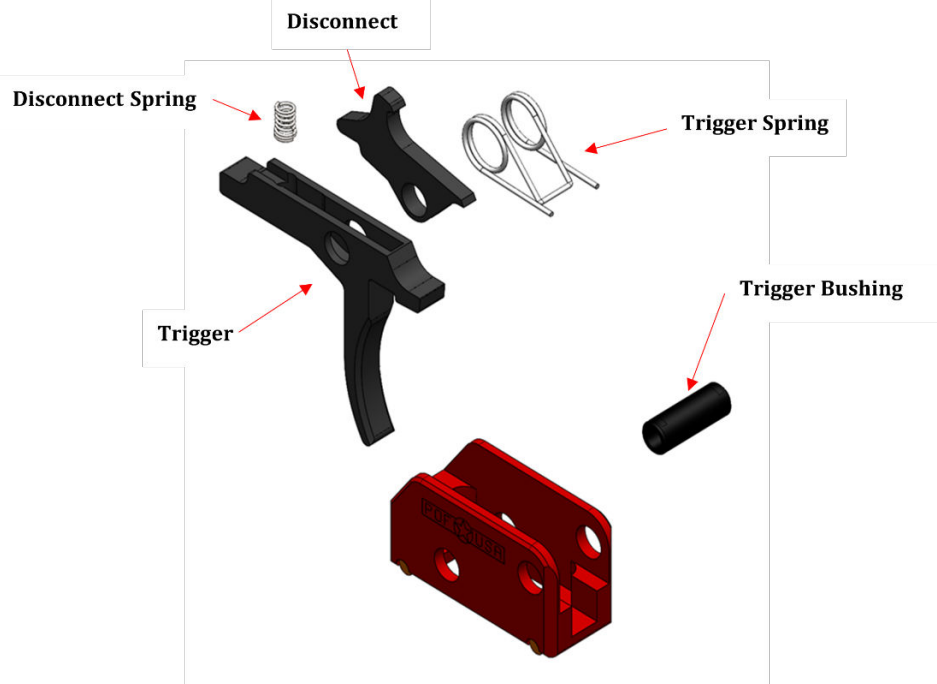

- 4.) Press the trigger bushing through the trigger housing, then lift the trigger, disconnect, trigger spring, and disconnect spring.
- 5.) Wipe all surfaces of the trigger housing, disconnect, trigger, hammer, and bushings with a clean cloth. Inspect all components of the trigger pack for wear. If you find abnormal wear or damage to any of the trigger components, contact your local gunsmith or POF-USA at technical@pof-usa.com.
- 6.) Reassemble components in the reverse order of disassembly. The two legs of the trigger spring will rest on the internal floor of the trigger housing when assembled. The two legs of the hammer spring rest on the trigger bushing when assembled.



CARE AND CLEANING

After each shooting session, at regular intervals, or whenever your firearm has been exposed to sand, dust, extreme humidity, condensation, immersion in water, or other adverse conditions; disassemble, clean, and lubricate it using the techniques shown in the video that can be viewed here:

<http://pof-usa.com/technical-support/>

- Use only cleaning and lubrication products specifically designed for use on firearms.
- Do not use wire brushes on aluminum surfaces such as the upper/lower receivers, as this can scratch the finish.
- Follow all manufacturer's instructions and cautions when using cleaning and lubrication products.
- Wherever the term CLP (Cleaner-Lubricant-Protectant) or the word lubrication is used in this manual, it is interpreted to mean that you can use any lubricant designed for use on firearms.
- Wherever propellant gases directly contact operating system parts, carbon will build up. Carbon cannot be removed with a brush and must be scraped.

Basic Procedures:

1. Disassemble the firearm as described on pages 28-35.
2. Clean the barrel bore with a bore brush, patches, and solvent using a cleaning rod.
3. Remove powder residue from all components and wipe with a clean cloth.
4. Only use a light application of oil on the riding surfaces of the bolt carrier group. Excessive oil will attract dust and dirt and may congeal in cold weather possibly interfering with the safe operation and reliable function of the firearm.

REASSEMBLY

Again, Be Sure the Firearm and Magazines are Completely Unloaded!

1. **Assemble BCG.** Start by reassembling the BCG in reverse order of the disassembly procedure on page 29.

FAILURE TO INSTALL CAM PIN MAY RESULT IN INJURY OR DEATH TO THE USER AND CATASTROPHIC DAMAGE TO THE FIREARM.

2. **Reassemble the charging handle and bolt carrier into the upper receiver:**
 - a. Turn the upper receiver upside down so that the top of the rifle is pointing toward the ground.
 - b. Put the charging handle into the upper, line up the locator tabs with the corresponding cut in the upper and drop the charging handle into the charging hand slot.
 - c. Turn the bolt carrier upside down and, **making sure the bolt is fully forward**, place the gas key of the bolt carrier in the channel of the charging handle, then push both the bolt carrier and the charging handle forward until the charging handle latch engages the upper receiver.

Care should be taken not to turn the upper receiver so that the bolt carrier can slide out the back of the upper receiver while the charging handle is unlocked. The bolt carrier will fall out of the upper receiver if the charging handle is not locked on the upper receiver.



3. **Assemble the upper receiver to the lower receiver:**
 - a. Make sure the hammer is cocked, place the selector on “SAFE” , and make sure both the take down pin and pivot pin are pushed completely to the right side of the lower receiver.
 - b. Make sure the bolt carrier is all the way forward in the upper receiver.
 - c. Put the upper receiver onto the lower receiver and slide the upper receiver all the way rearward against the threaded section of the butt stock.
 - d. Push the pivot pin into the receiver until the detent locks in the hole of the pivot pin. Push the take down pin into the receiver until the detent locks in the hole of the take down pin.

POF-USA FUNCTION TEST

Always keep the muzzle pointed in a safe direction. Treat every firearm as if it is loaded. Perform this test before every use of your firearm.

This function test should be completed before every use of your firearm to ensure the firearm is safe to operate. If your firearm fails at any of the steps in this function test, follow the steps outlined in the “Disassembly” and “Care and Cleaning” sections to clean the firearm and trigger group. Attempt this function test again once you have maintained your firearm. If the firearm fails the function test again, contact your gunsmith, certified POF-USA armorer, or Patriot Ordnance Factory at 623-561-9572 or technical@POF-USA.com for assistance.

- 1.) Verify the firearm is clear of any ammunition. There should be no magazine in the firearm, and no round in the chamber.



- 2.) Operate the charging handle, pulling it completely to the rear, then letting go to let it freely go into battery.
- 3.) Rotate the selector (safety) to the safe position.



- 4.) Press the trigger. The hammer should not fall, and there should be no audible noise.
- 5.) Rotate the selector (safety) to the fire/semi position.



- 6.) Press the trigger. There should be an audible “click” as the hammer falls.
- 7.) Continue pressing and hold the trigger to the rear. While maintaining pressure on the trigger, operate the charging handle (pulling it completely to the rear, then letting go to let it freely go into battery), then slowly rotate the selector to the safe position. Keep pressure on the trigger between these two operations. The trigger should reset (you should hear a “click”) but not release the hammer. There will be moderate resistance as you rotate the selector.



If you have a semi-automatic firearm, your function test is complete. If your firearm is fully automatic, proceed with steps 8-10.

- 8.) If equipped, rotate the selector to the automatic position.
- 9.) Press and hold the trigger to the rear, operate the charging handle three times.



- 10.) Release the trigger. There should be no trigger reset, and the hammer should have already fallen.

Your function test is now complete.

WARRANTY POLICIES

All POF-USA products are manufactured using the finest quality materials and have a limited lifetime warranty. All POF-USA firearms are warranted to be free from defective materials and workmanship. POF-USA will repair or replace only those parts as determined to be defective by the factory. This warranty is limited and does not extend to careless handling, abuse and misuse, unauthorized adjustments or modifications, use of improper ammunition, excessive or unreasonable use, rust or corrosion or barrel obstruction.

Altering or modifying parts is dangerous and will void the warranty. Your POF-USA firearm was manufactured to perform properly with the original parts as designed. It is your responsibility to make sure any parts you install are made for this firearm, installed correctly, and that neither the originals nor the replacement parts are altered or changed. Your POF-USA firearm is a complex precision tool with many parts that must operate correctly with other parts in order to maintain proper and safe operation. Putting your firearm together improperly or with incorrect or modified parts can result in a damaged firearm, serious personal injury, or death to you and/or others through malfunction. Always have a qualified armorer or gunsmith work on your POF-USA firearm systems or other firearms.

Shipping to and from POF-USA facilities, government fees, damages caused by failure to perform normal maintenance, sales outside the United States, damages due to high velocity, high pressure, reloaded, remanufactured, or other non-standard ammunition, consequential or incidental damages and /or expenses, any unauthorized repair, modification, misuse, abuse, or alteration of the product is not covered by this warranty.

It is the responsibility of the owner to assure the firearm is properly maintained.

To help us assist you better, please register your firearm through our Warranty Registration online form below. Warranty is established by registering online at:

<https://pof-usa.com/warranty-registration/>

For further technical assistance or to obtain warranty information on your POF-USA firearm, email technical support at technical@pof-usa.com.

Customers pay shipping when returning a product to POF-USA. POF-USA will pay return shipping charges for warranty repaired products to customers.



MAINTENANCE AND WEAR PARTS

POF has been manufacturing firearms and firearm components since 2002. Through extensive testing and use we have learned that any machine, including all firearms, will have certain parts that occasionally require maintenance, adjustments, or replacement. “Wearable” or “Consumable” parts are parts that, by their very nature, through use will not maintain absolute factory specifications forever and will need to be inspected periodically for functionality and safety. Some of these parts may have a finite life cycle which may be affected by use, abuse, or maintenance.

To address these parts on our products, it is recommended that a POF firearm be disassembled and inspected by a certified POF armorer or gunsmith at least annually. Many of the problems that The Factory has encountered with returned firearms involve these “Wearable” or “Consumable” parts and/or improper maintenance and cleaning.

“Wearable” or “Consumable” Parts

Below is a sample list of some wearable or consumable parts:

Springs

Springs are very important to the safe and reliable operation of any firearm. They tend to be one of the most overlooked parts when performing maintenance. When they become worn through use they take a set (become weak). This can change or adversely affect the operation or reliability of the firearm. In addition, any spring can be damaged, weakened, worn, or broken based on the use or abuse of the firearm and therefore should be inspected regularly and replaced as needed.

Extractors

Extractors are a high use component that must function correctly every time the firearm feeds or extracts a cartridge from the chamber to complete the cycles of operation. They are considered a “Wearable” part and should be inspected regularly and replaced as needed.

Ejectors

Ejectors are also a high use component that must function correctly every time the firearm ejects a cartridge from the chamber. They are considered a “Wearable” part and should be inspected regularly and replaced as needed.



Firing Pins

The firing pin contacts the cartridge primer anytime a round is loaded and anytime the rifle is fired. This can cause damage to the face of the firing pin with use, and therefore should be inspected regularly and replaced as needed.

Cam Pins

A cam pin is a crucial component that operates every time the rifle is cycled and is the main component that locks and unlocks the action. This part is a high cycle component and therefore should be inspected regularly and replaced as needed.

Although we recommend that “Wearable” or “Consumable” parts be inspected regularly, it does not mean that these parts need to be replaced every time they are inspected. POF products are manufactured to the highest standards and tend to outlast other products on the market. We recommend these inspections to ensure the continued reliability and long life of your POF product.

PARTS POLICY

Our Service Department maintains a full stock of replacement parts. Even though most gunsmiths have the knowledge, training, and the ability to make necessary repairs to your firearm, the skill and workmanship of any particular 3rd party gunsmith is beyond our control.

Should your firearm ever require service, we strongly recommend that you return it to POF-USA. A firearm is a precision instrument, and some replacement parts will require individual fitting to ensure correct operation. A wrong part, improper fitting, or incorrect mechanical adjustment may result in an unsafe condition or dangerous malfunction, damage to the firearm, or cause possible serious injury to the shooter or others.

POF-USA parts may only be installed in conjunction with: 1) Other parts that were designed and/or sold by POF-USA or 2) Parts that adhere to the safety and functional dimensional requirements of the M16, M4 carbine, or any subsequent variant military specifications or data packages.

IF ANY PART IS ORDERED WITHOUT RETURNING THE FIREARM TO POF-USA, the customer bears full responsibility for ensuring that the part supplied is correct for their particular firearm and is properly installed and fitted by a qualified gunsmith.

POF-USA IS NOT RESPONSIBLE FOR THE FUNCTIONING OF ANY FIREARM IN WHICH REPLACEMENT PARTS ARE INSTALLED BY OTHERS.



TECHNICAL INFORMATION AND RECOMMENDATIONS

Magazines

POF-USA only recommends the use of magazines that have anti-tilt followers in any of our 5.56 NATO and 300 AAC Blackout caliber firearms. Here are three examples of recommended magazines that have anti-tilt followers.

Magpul Gen 3 PMAGS



Mission First Tactical



Lancer L5

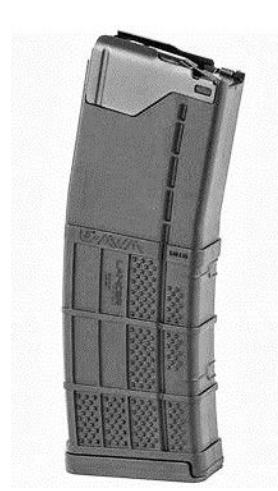

RENEGADE HANDGUARD

The Minuteman family of Firearms use a unique mounting and locking system for the handguard. The narrow profile handguard is slipped over the barrel nut and locked horizontally into place using two front sling mounts, one on the right side and one on the left side. Additionally, two screws located at the bottom of the handguard are tightened and effectively clamp the handguard into place.

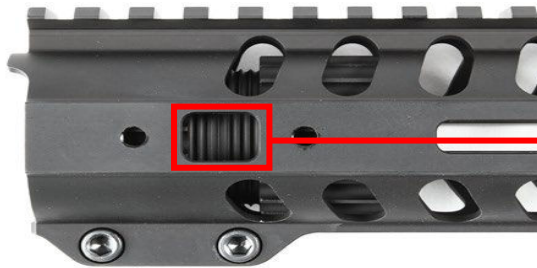

Once the handguard is slid into position the cutout in the barrel nut should be visible in the window of the handguard as shown here.

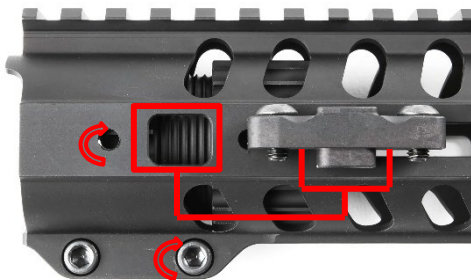

The square “block” on the sling mount will fit into the window of the handguard and “lock” into the barrel nut. Two screws are then tightened on the sling mount to **25 inch lbs.** This process is accomplished on both the right and left side of the weapon. The bottom two screws are also tightened to **25 inch lbs.**

FASTENERS

Fastener Reference and Suggested Tools									
Location On Weapon	Fastener Description		Quantity			Suggested Tool			
	Description	Size	P415	P-308	CMR	Tool Size	Description		
Hand Guard, Wedge Block Screw (older)	Socket Set Screw, Cup Point	10-32x 3/16	4	4		3/32	Allen Wrench, T-Handle		
Rail Clamp Screws	Socket Head Cap Screw	10-32 x 3/8	2	2	2	5/32	Allen Wrench, T-Handle		
Hand Guard, Back Bone Screw (older)	Socket Cap Screw, Flat	8-32 x 3/8	3	5		3/32	Allen Wrench, T-Handle		
Hand Guard, Back Bone Screw	Socket Cap Screw, Flat	8-32 x 3/8	3	5	3	T20	TORX		
Hand Guard, Fail Safe Screw, Bottom	Socket Set Screw, Cup Point	10-32 x 3/8	1			3/32	Allen Wrench, T-Handle		
Hand Guard, Fail Safe Screw, Side MRR/P308	Socket Set Screw, Cup Point	1/4-28 x 3/8		2		1/8	Allen Wrench, T-Handle		
Hand Guard, Fail Safe Screw, Side P Series	Socket Cap Screw, Low Head	10-32 x 1/4	2			3/32	Allen Wrench, T-Handle		
Swivel Mount Screws (older)	Socket Cap Screw, Flat	10-32 x 3/8	2	2		1/8	Allen Wrench, T-Handle		
Hand Guard Section Screws	Socket Cap Screw, Flat (5 slot)	10-32 x 3/8	2	2		T25	TORX		
Hand Guard Section Screws	Socket Cap Screw, Flat (12 slot)	10-32 x 3/8	3	3	3	TORX	TORX		
Hand Guard Section Screws	Socket Cap Screw, Flat (8 slot)	10-32 x 3/8	2	2	2	T25	TORX		
Sling Mount, Quick Release	Socket Cap Screw, Flat	10-32 x 3/8	2	2	2	T25	TORX		
Grip Mount Screw, Long	Socket Cap Screw	1/4-28 x 1.5	1	1	1	3/16	Allen Wrench, T-Handle		
Grip Mount Screw, Short	Socket Cap Screw	1/4-28 x 1	1	1	1	3/16	Allen Wrench, T-Handle		
Ambi Selector Screw (older)	Flat Socket Cap Screw	4-40 x 1/4	1	1	1	1/16	Allen Wrench		
Ambi Selector Screw	Flat Socket Cap Screw	4-40 x 1/4	1	1	1	T10	TORX		
Trigger Anti Walk Kit Screws (older)	Socket Cap Screw, Button Head	6-40 x 15/64	2	2	2	5/64	Allen Wrench		
Trigger Anti Walk Kit Screws	Socket Cap Screw, Button Head	6-40 x 15/64	2	2	2	T10	TORX		
Ambi Bolt Release Screw			1	1	1	1/16	Allen Wrench		
Bolt Catch Screw			1	1	1	1/16	Allen Wrench		
Ambi- Mag Release Screw, Gen 4			1	1	1	1/16	Allen Wrench		
Nylon Tension Screws, Gen 4		6-32 x .188	2	2	2	1/16	Allen Wrench		
Jam Nut for .308 WIN & 6.5 Creedmoor	Socket Set Screw, No point		1	1	1	20mm	Open End Box End Combo Wrench		
Muzzle Device for .308 WIN & 6.5 Creedmoor	5/8-24 Barrel Thread		1	1	1	3/4	Open End Box End Combo Wrench		
Jam Nut for 5.56 NATO	1/2-28 Barrel Thread		1			20mm	Open End Box End Combo Wrench		
Muzzle Device for 5.56 NATO	1/2-28 Barrel Thread		1			3/4	Open End Box End Combo Wrench		
Jam Nut for 6.8 SPC, 7.62X39, & 300BLK	5/8-24 Barrel Thread		1			20mm	Open End Box End Combo Wrench		
Muzzle Device for 6.8 SPC, 7.62X39, & 300BLK	5/8-24 Barrel Thread		1			3/4	Open End Box End Combo Wrench		
Mil-Spec Castle Nut, Buffer Tube	Mil-Spec Standard Part		1	1	1	MAG535	Magpul Armorer's Wrench		

Rebel .22 Fastener Reference and Suggested Tools									
Location On Weapon	Fastener Description		Quantity			Suggested Tool			
	Description	Size	Rebel	.22		Tool Size	Description		
Barrel Mounting Screws	Socket Cap Screw, Flat	8-32x 3/8	4			T20	TORX		
Mag Release Screw	Socket Set Screw, Cup Point	8-32x 1/8	1	1		5/64	Allen Wrench		
EPD Adapter	1/2-28 Barrel Thread		1	1		5/8	Open End Box End Combo Wrench		



DIAGRAMS

The Following parts diagrams are provided to help you identify individual parts in your firearm.

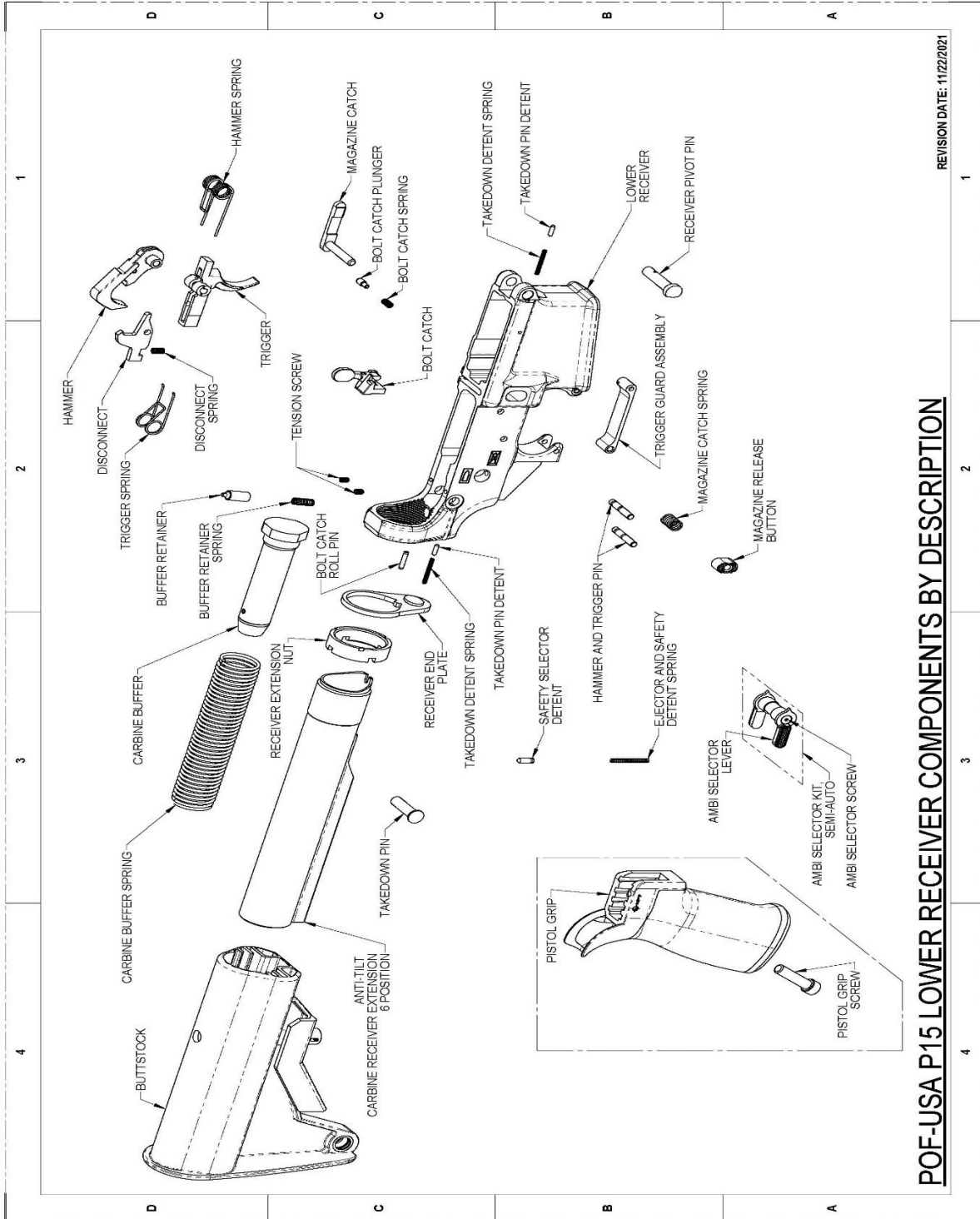

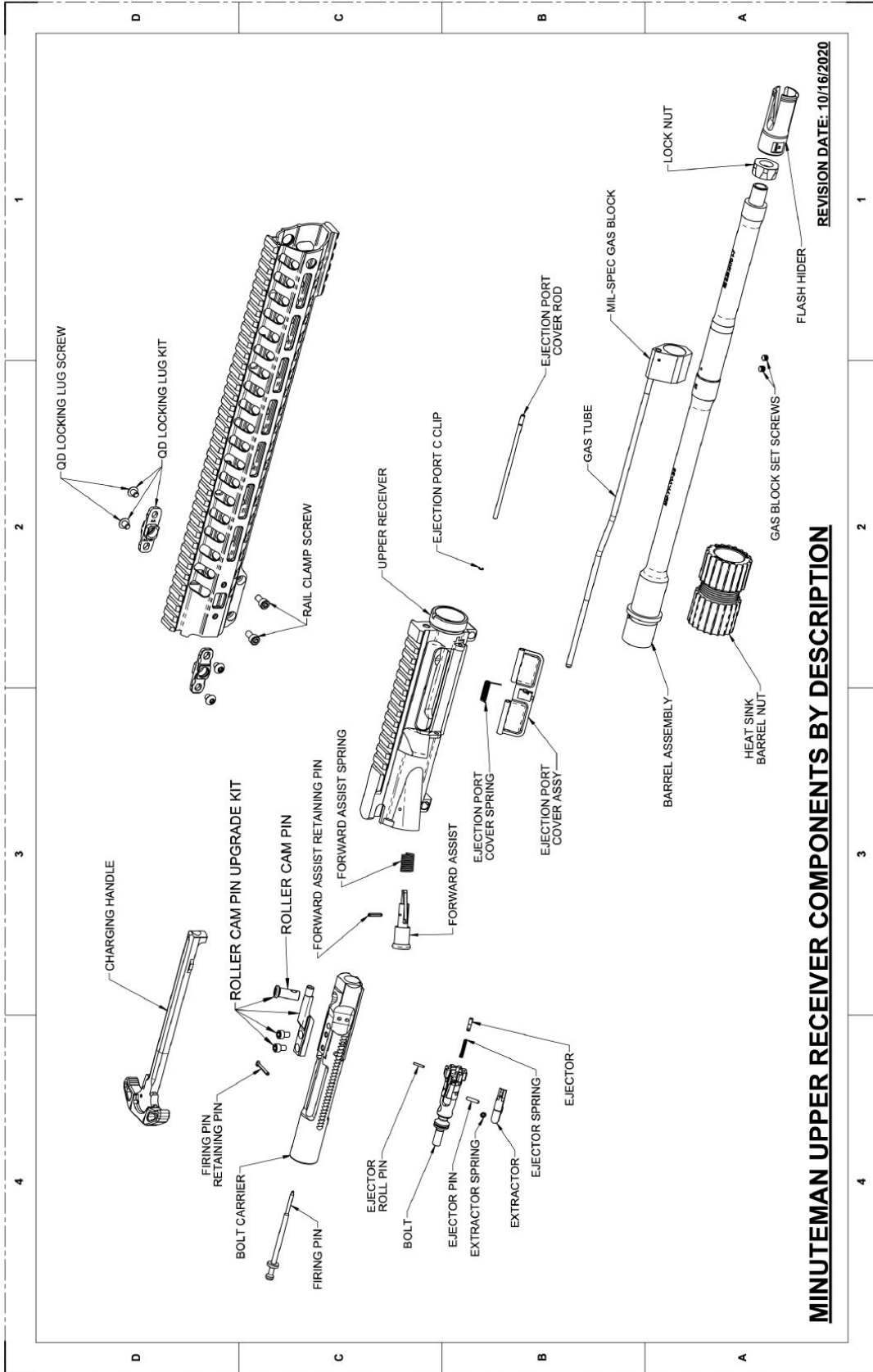

NOTES



